

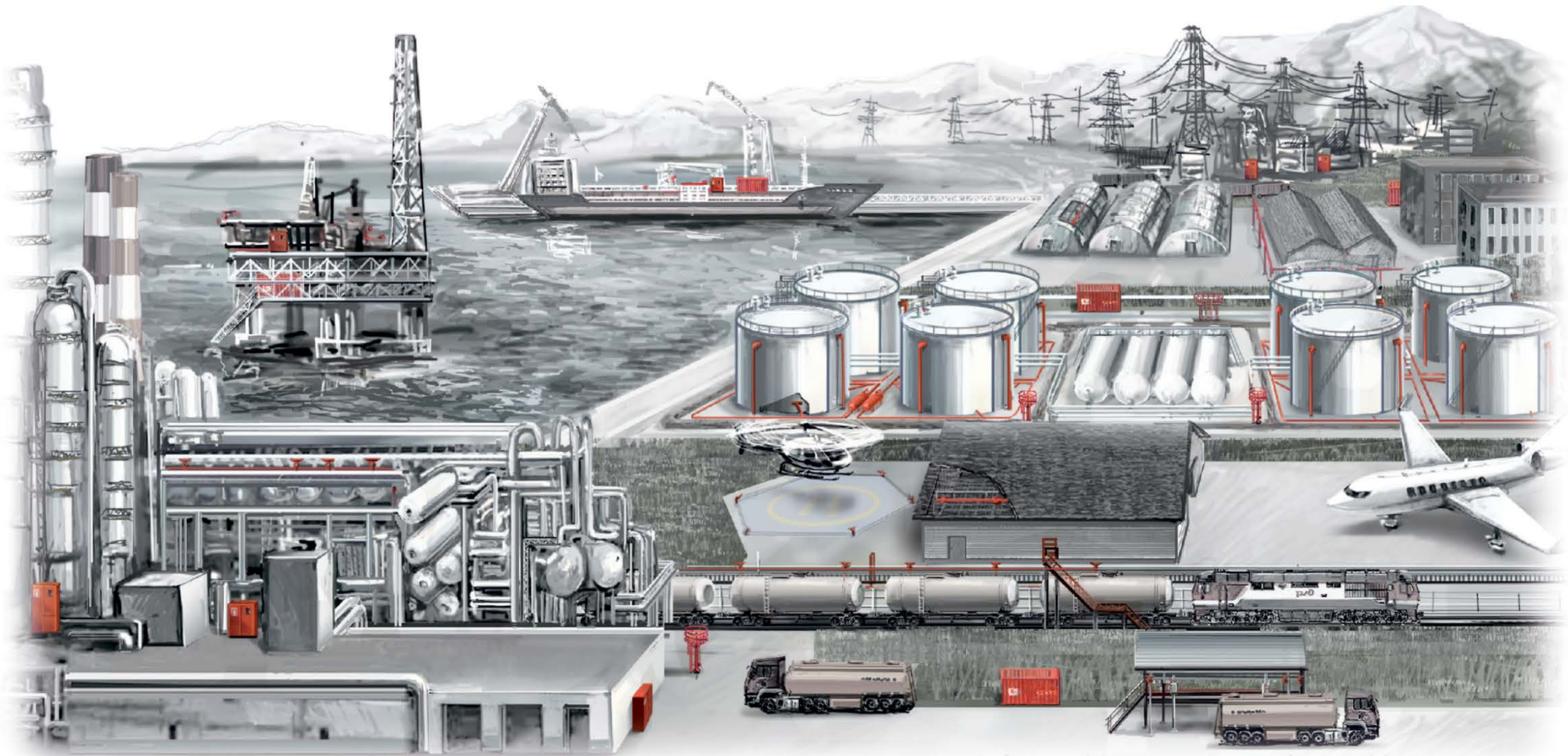

**RUSSIAN MANUFACTURER OF  
FIREFIGHTING EQUIPMENT AND FOAM CONCENTRATES  
DEVELOPER OF DESIGN SOLUTIONS  
FOR FOAM FIRE EXTINGUISHING SYSTEMS**



**Pozhneftekhim LLC**  
+7 (812) 309 91 09

**TMC Pozhneftekhim LLC**  
+7 (499) 703 01 32

**mail@pnx-spb.ru**  
**www.pnx-spb.ru**

# History and areas of business



**Development, manufacturing and shipment of firefighting equipment and foam concentrates**

**Development of Concepts of anti-fire defense, Special technical conditions, Fire safety measures**

**Expertize of organizational and technical design solutions for fire safety, evaluation of their correspondence to official codes and standards**

**Consulting on design, construction, reconstruction and put into operation stages**

**R&D in development of firefighting equipment and fire extinguishing substances**

**Organization of training (refresher) courses for professionals in industrial and fire safety, designers of fire extinguishing systems**



## Dear current and future customers of Pozhneftekhim!



**Evgeniy Veselov**

Director general of Pozhneftekhim LLC

Before Pozhneftekhim:  
Lieutenant colonel of internal service at MIA,  
Head of fire defense department

For 14 years by now, our company has been **designing, manufacturing and installing systems of fire protection** on hazardous industrial objects. Heads of Pozhneftekhim have been collaborating with largest companies of oil&gas, petrochemical sectors and other industry branches.

This brochure features firefighting equipment and foam concentrates produced by Pozhneftekhim. This is not the complete list of our products. Our assortment outnumbers 14 thousand articles, which are **significant product modifications** that differ in functionality depending on the characteristics of the industrial venue.

We maintain proper **research and development program** in fire defense technologies. New specimens are tested at the certified testing area of over 1 thousand sq m. The production venue of Pozhneftekhim occupies over 4 thousand sq m overall.

The history and sustainable development of the company is guarantee that Pozhneftekhim is reliable partner. If you need **functional, efficient and financially sound firefighting systems**, you are welcome to address Pozhneftekhim. We guarantee comfort at each stage of works, from design to commissioning of your object.

Fire safety of industrial objects is an essential element of state stability. We work for **reliability and confidence** in our future day.

# Geography and supplies

## Supplies of products, exports

-  Russian Federation
-  Republic of Belarus
-  Republic of Kazakhstan
-  Republic of Azerbaijan
-  Republic of Uzbekistan
-  Bulgaria

## Geography of Pozhneftekhim

-  Manufacturing of fire fighting equipment in Tula region
-  Manufacturing of foam concentrates in Moscow region
-  Trade and manufacturing company Pozhneftekhim (Moscow)
-  Pozhneftekhim headquarters (Saint-Petersburg)
-  Partner in Belarus Sever Group of companies
-  Partner in Kazakhstan Security Systems Bureau

**Our customers**



# Advantages of Pozhneftekhim



- **Russia developer and manufacturer of firefighting equipment and foam concentrates** - components of foam fire extinguishing and water spraying systems for industrial buildings and constructions
- Maintenance of the customer, installation supervision, commissioning, training of personnel on the venue, **participation in acceptance testing on the site**
- Proprietary **manufacturing venue** of over 4 thousand sq m, certified **testing area** of over 1 thousand sq m
- **Technical support of design:** special technical conditions, fire safety measures, standard solutions, installation drawings, individual developments under customer's request
- Qualified personnel, **quality control of manufacturing and management GOST, ISO**
- EMERCOM of Russia license and access to works on **especially hazardous objects** by the Association of designers of fire protection systems

Pozhneftekhim collaborates with design institutions, engineering companies, buying companies, construction and installation firms, provides services of warranty maintenance.

# Organizational structure

## Board of Directors, Pozhneftekhim Group

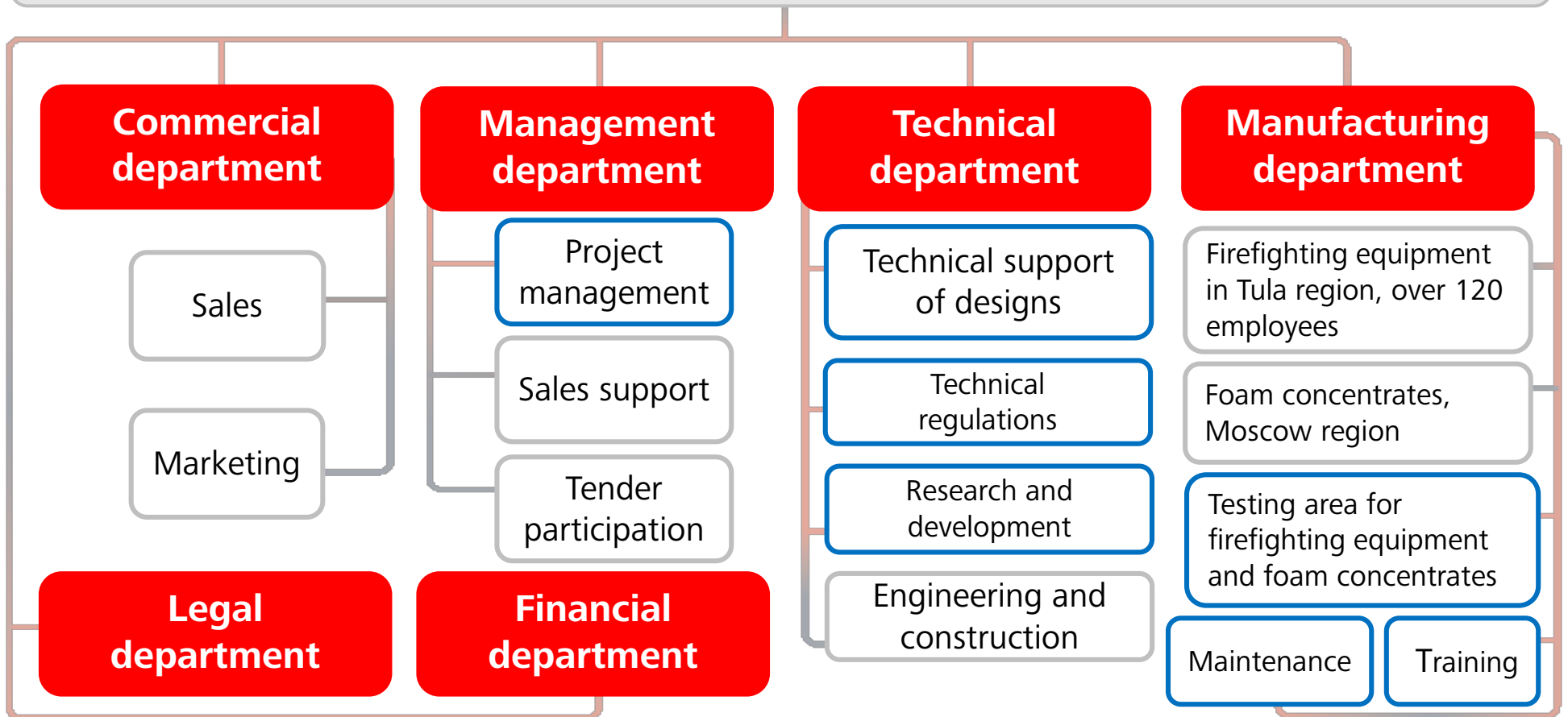

Well-balanced organizational structure helps our company to process customer requests efficiently and ensure collaboration of over 30 departments.



# Manufacturing of firefighting equipment



# Firefighting equipment

## Foam generators

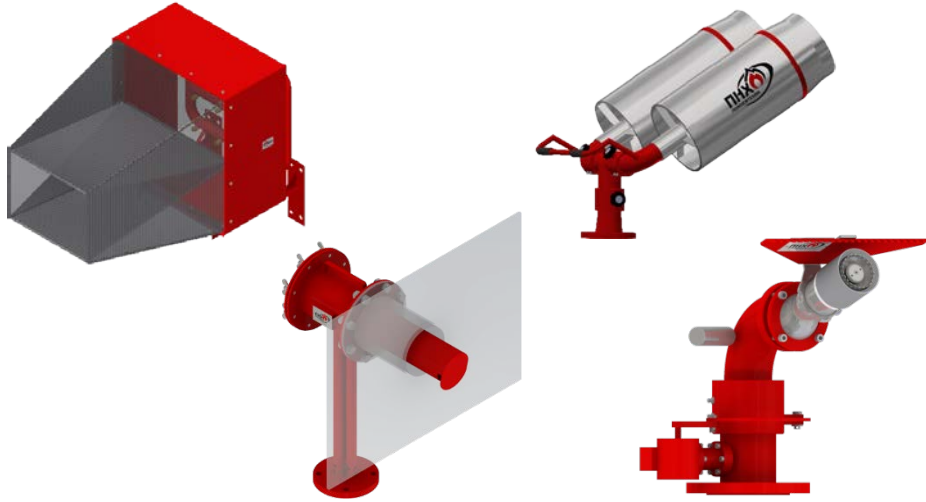

## Dosing systems

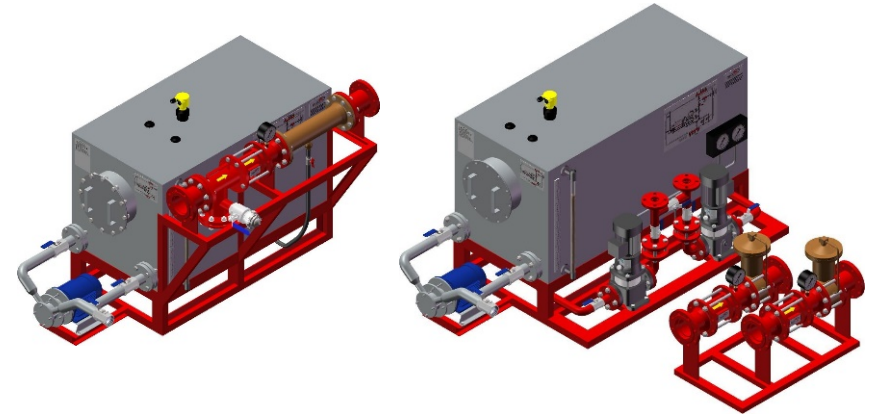

## Bladder tanks



## Block-modular buildings





# Firefighting equipment

## Fire towers, fire monitors



## Fire hydrant blocks, fire hose cabinets

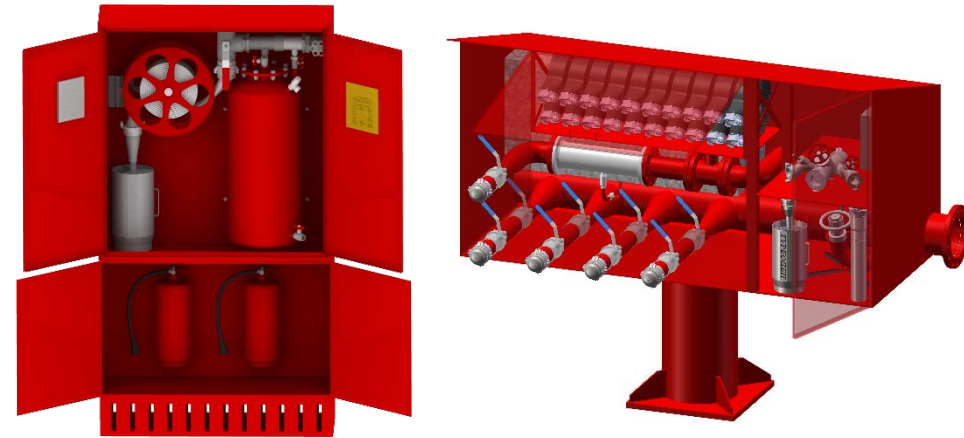

## Fire filters, supplementary equipment

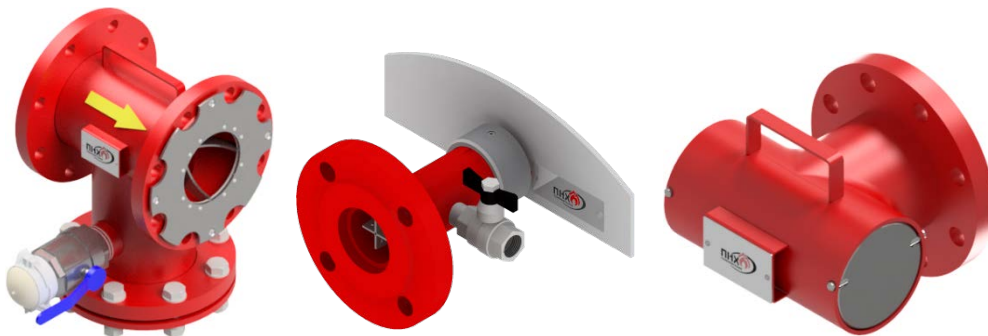

## Nodes for fire fighting technique

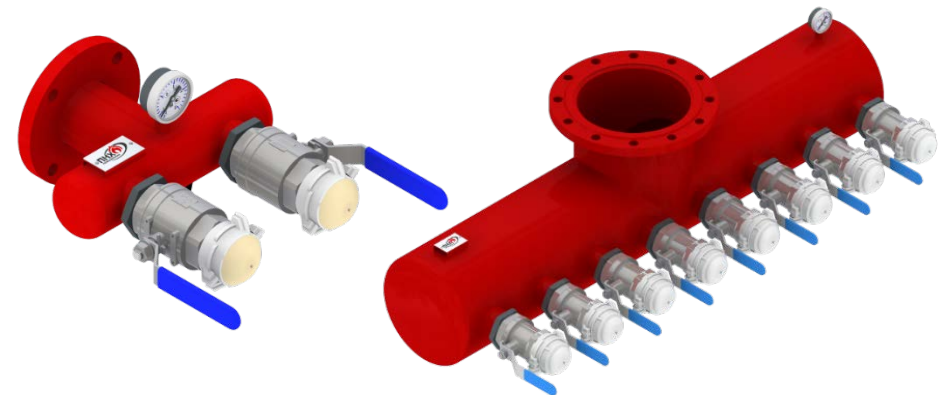

# Quality control: testing area

Certificate of the State regional center for  
standardization, metrology and testing in  
Nizhniy Novgorod region  
№4601/1600-17 of 14.07.2017

Passport of the  
Stand for hydraulic tests  
№ к Р-005-2013-СГИ-ПНХ (2015)



# Stand for hydraulic tests



**Bladder tanks**

**Nozzles for water curtains**

**Nozzles for foam and water spraying**

**Fire monitors**

**Foam generators**

**Firefighting pressure proportioners**

**Control of firefighting products' manufacturing performed in accordance with requirements of GOST ISO 9001-2011 (9001-2008).**

**Certificate of the Federal agency for technical regulation and metrology №MCK.OC1.A0640 dated 10.06.2015.**

**Block containers for foam fire extinguishing**

**Proportioners:  
turbine inline, balanced, inductors**





# Manufacturing of foam concentrates



One of reactors



Filtration



Testing fire box

**Pozhneftekhim started its own production of foam concentrates in 2011. Since then, over 300 compositions have been developed and over 80 compositions accepted for production.**

# Foam concentrates and wetting agents



Pozhneftekhim  
production capacity

**8k tones/year**  
**30 tones/day**



Pozhneftekhim manufactures foam concentrates under trademark Aquaform® since 2011. The compositions are produced strictly in accordance with GOST. We can develop individual products that consider the specifics of protected objects (type of waters, combustible matter, climate conditions of the region).

**AFFF**

**AFFF/AR**

**S**

**S/AR**

**WA**

**Ammonia's  
spillage  
covering**

**Filling of fire  
extinguishers**

# Quality control: laboratory

Development and improvement of compositions for fire extinguishing

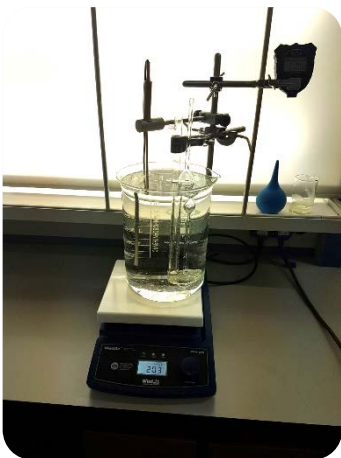

Viscosity testing



Scales



Ionometer, viscosimeter, mixer



Freezing point testing



Additional equipment



Tensiometer



# Quality control: fire extinguishment



**Over 200 tests**  
required to develop  
one composition.



**Fire extinguishing  
capacity**  
of Aquafom concentrates  
evaluated at the  
testing area.

# Projects completion stages

Concept – Special technical conditions – Design – Expertize – Construction – Installation supervision – Commissioning – Maintenance

Pozhneftekhim is responsible  
for all stages of fire  
fighting system installation



# Protected objects

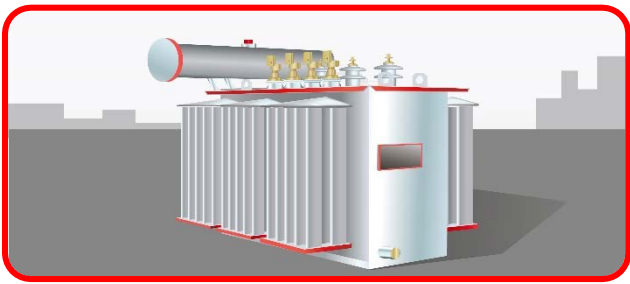
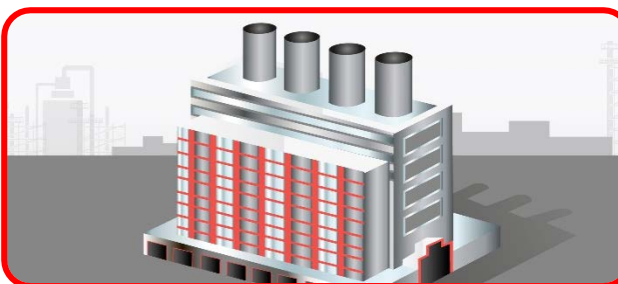
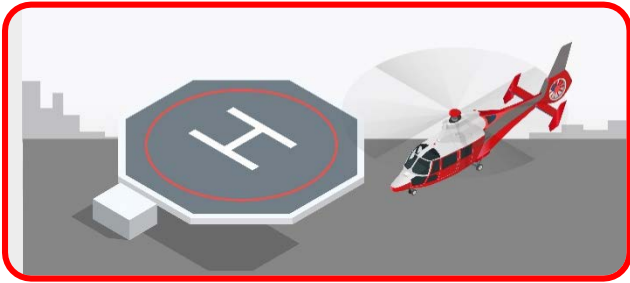
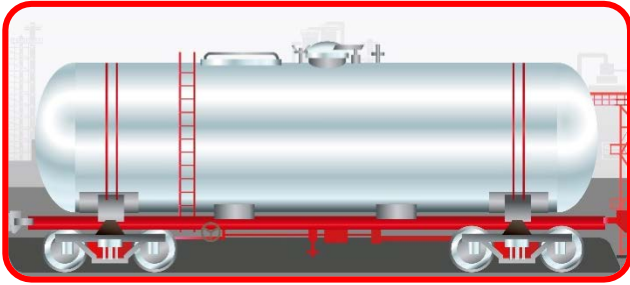

Pozhneftekhim supplies  
firefighting products to  
industrial and  
manufacturing venues.



# Design of firefighting systems

## Supply of design stage and collaboration with customers

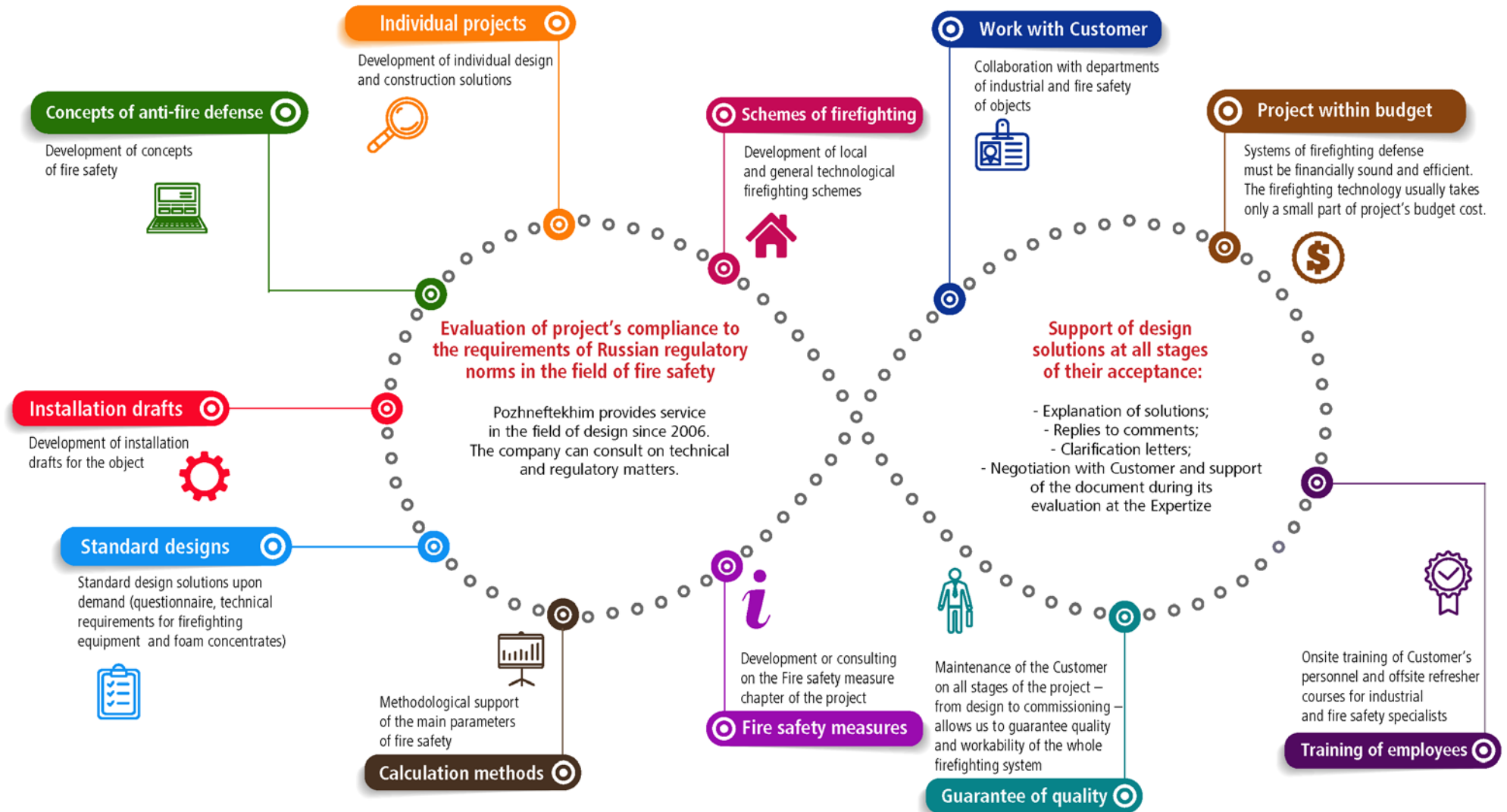

# Concepts of anti-fire defence

Scheme representing the collaboration of technical regulations department of Pozhneftekhim and the customer when developing concepts of anti-fire defense.

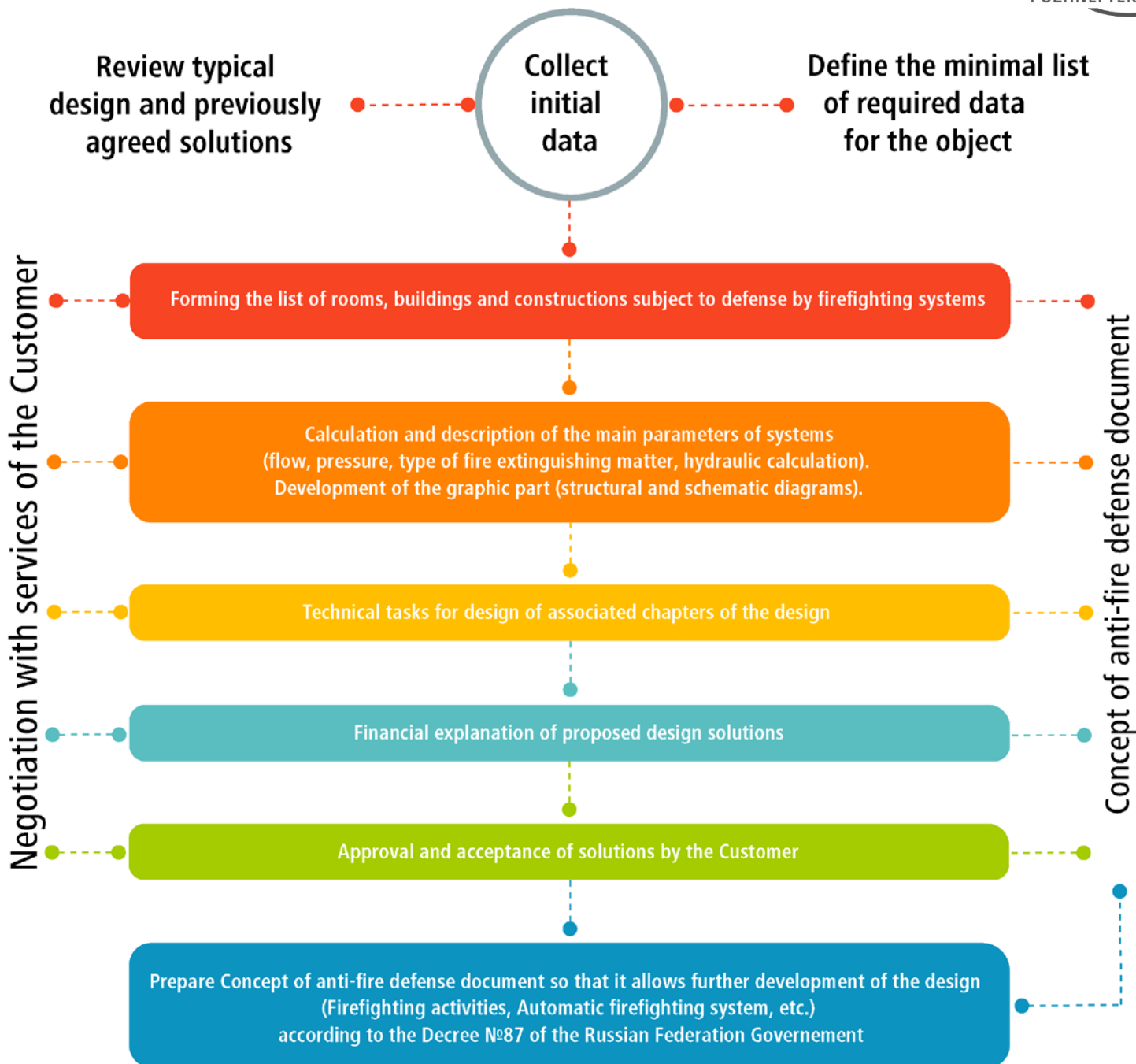

# Special technical conditions for fire safety

Scheme representing the collaboration of technical regulations department of Pozhneftekhim and the customer when developing special technical conditions.

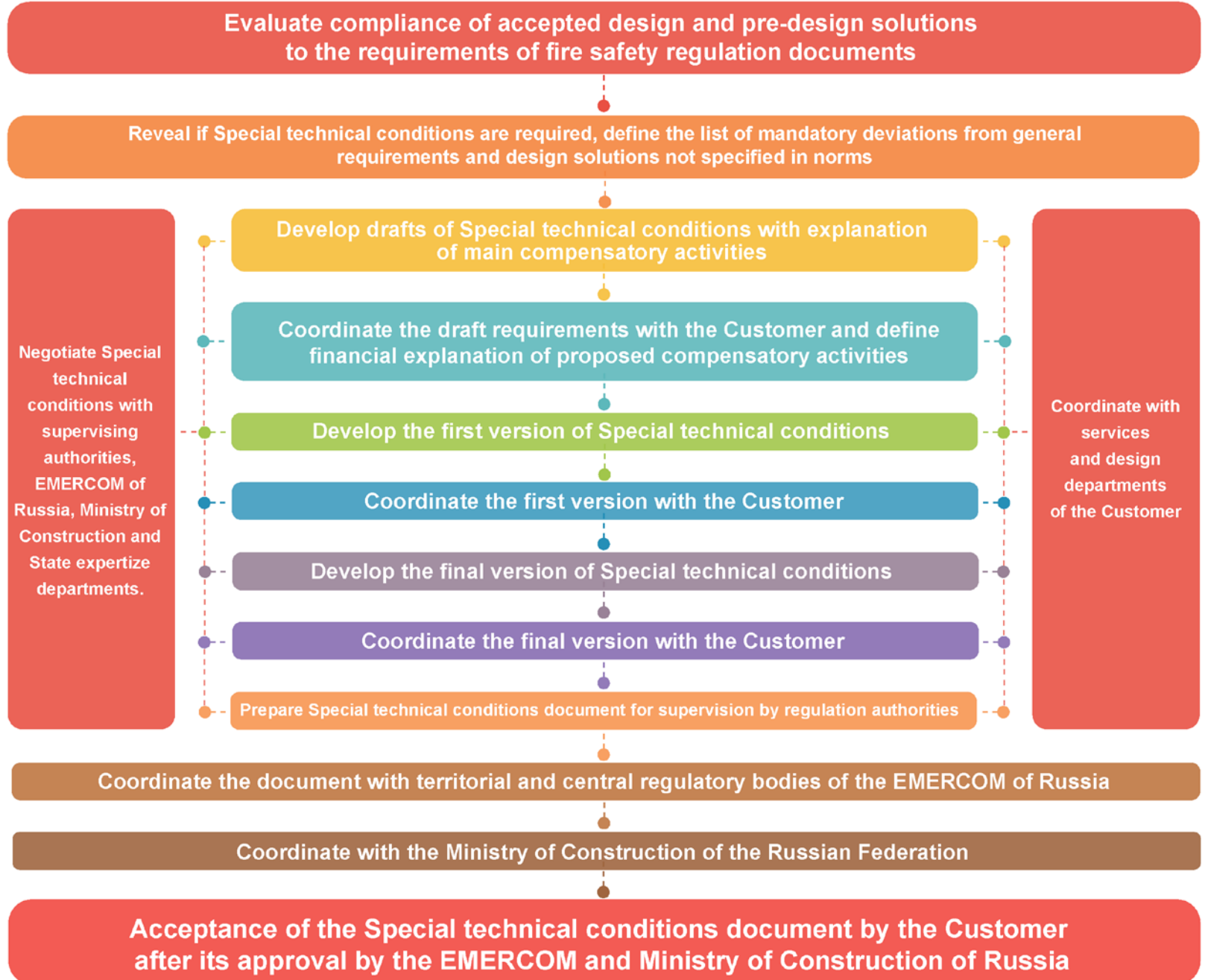

Negotiate Special technical conditions with supervising authorities, EMERCOM of Russia, Ministry of Construction and State expertize departments.

Coordinate with services and design departments of the Customer



# Fire safety measures

Scheme representing the collaboration of technical regulations department of Pozhneftekhim and the customer when developing fire safety measures chapter of the design documentation.

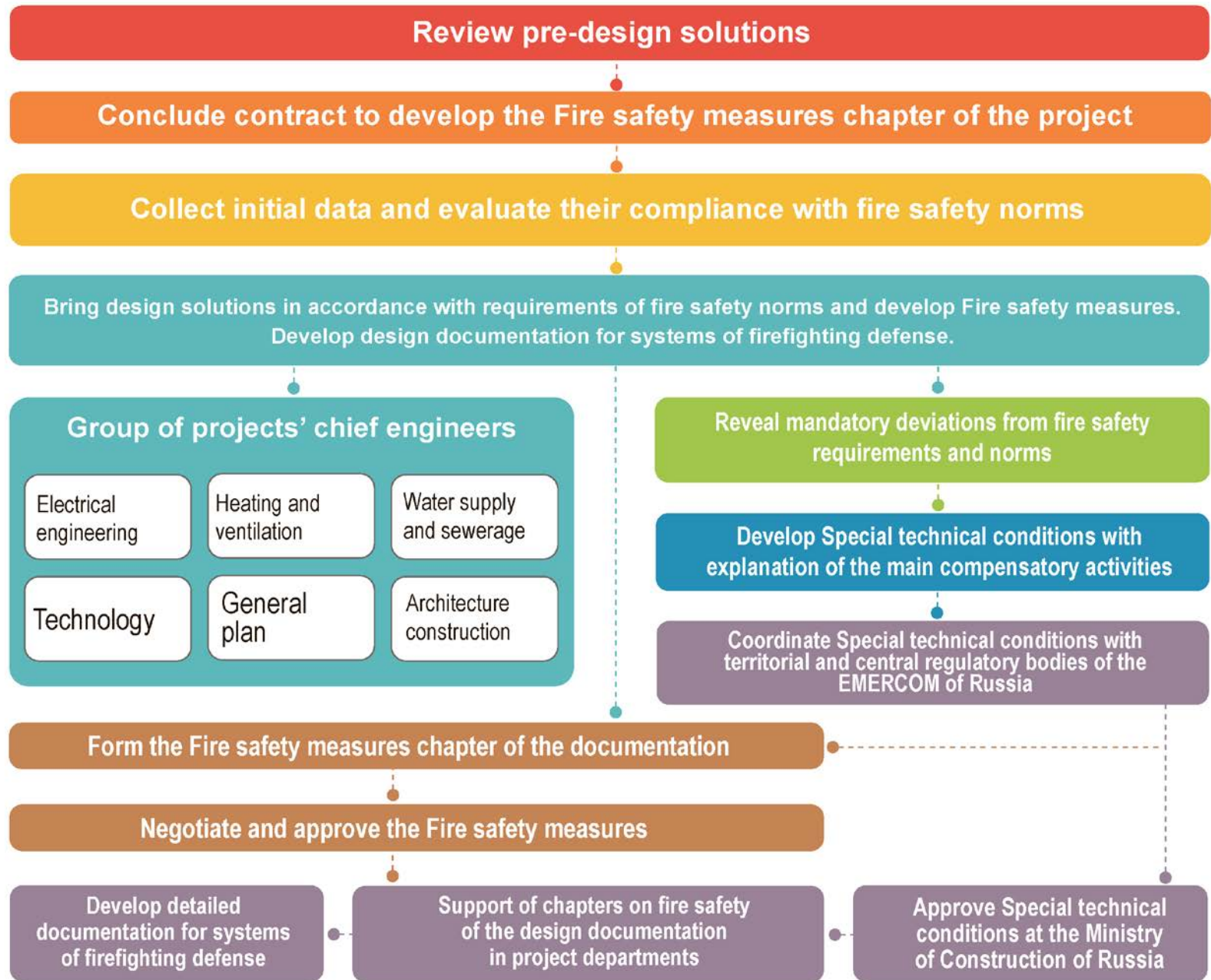



### **Pozhneftekhim LLC**

Office: 196084, Saint-Petersburg, Moscovsky prospect, 130, letter A, room 17H

Postal address: 196135, Saint-Petersburg, post office box 2

Phone : +7 (812) 309 9109

### **Trading and manufacturing company**

#### **Pozhneftekhim LLC**

Office: 109428, Moscow, Ryazansky prospect, 10, bldg. 18, office 6A1

Legal address: 109028, Moscow, Khokhlovsky lane, 15, area 1, room 2

Phone: +7 (499) 703 0132



[mail@pnx-spb.ru](mailto:mail@pnx-spb.ru)

[www.pnx-spb.ru](http://www.pnx-spb.ru)

#### **Pozhneftekhim Limited Liability Company**

License of EMERCOM of Russia №2-Б-01526 dated 26.12.2013

License of the Ministry of Education of the Tula region №0133/03315 dated 30.09.2016

Certificate of Association of designers of fire protection systems SRO №П-150-АБ-140 dated 05.08.2016 (access to works that influence safety of objects of capital construction including hazardous and technically complicated objects)